



STEEL STAR
www.greatforming.com



Over 15 Years Roll Forming Machine Of Experience



Clear Plans Clear Prices. Make The Best Plan For You

Roll Forming Machine

Contents



Company Profile



Foreign Partners



Exhibitions



STEEL STAR
www.greatforming.com

1. Roof Sheet Roll Forming Machine

2. Light Keel Stud And Track Roll Forming Machine

3. Shutter Door Roll Forming Machine

4. C/Z Purlin Roll Forming Machine

5. Ridge Cap Roll Forming Machine

6. Barrel Corrugated Roll Forming Machine

7. Floor Deck Roll Forming Machine

Contents

8. Car Board Roll Forming Machine

9. Rain Gutter / Downspouts Roll Forming Machine

10. Light Keel Villa Frame Roll Forming Machine

11. Guardrail Plate Roll Forming Machine

12. Foam/Rock Wool Roof Sheet Composite Production Line

13. Decoiler / Auto Stacker Roof Panel Sheet Machine

14. Bending Machine / Guillotine Shearing Machine

15. Steel Coil Slitting Line Machine

16. Solar Bracket Machine

17. Steel Pipe Making Machine

18. Various products can be customized



Product catalog

Contents



Shipping Abroad



Service



Contact Us



STEEL STAR
www.greatforming.com

Company Profile

**The factory covers an area
of 20000m²**

Real production factory

24 hours online service

**15 years of industry
experience**

**Cooperated with more
than 30 countries**

Clear Plans Clear Prices

**German copra design
software**



**Has many foreign
partners**

**Obtained multiple
international certifications**



STEEL STAR
www.greatforming.com

Company Factory View

Factory Area



Raw Material Machining Workshop



Assembly Production Workshop





STEEL STAR
www.greatforming.com

Company Honor Certificate





STEEL STAR
www.greatforming.com

Foreign Partners





STEEL STAR
www.greatforming.com

Exhibitions

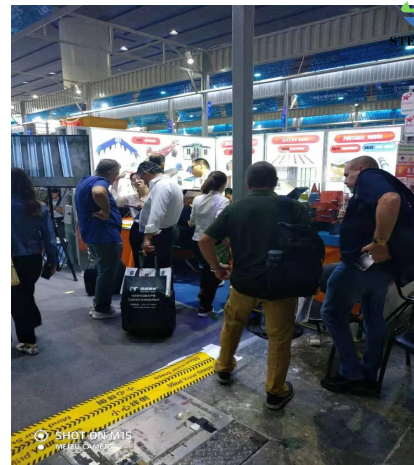
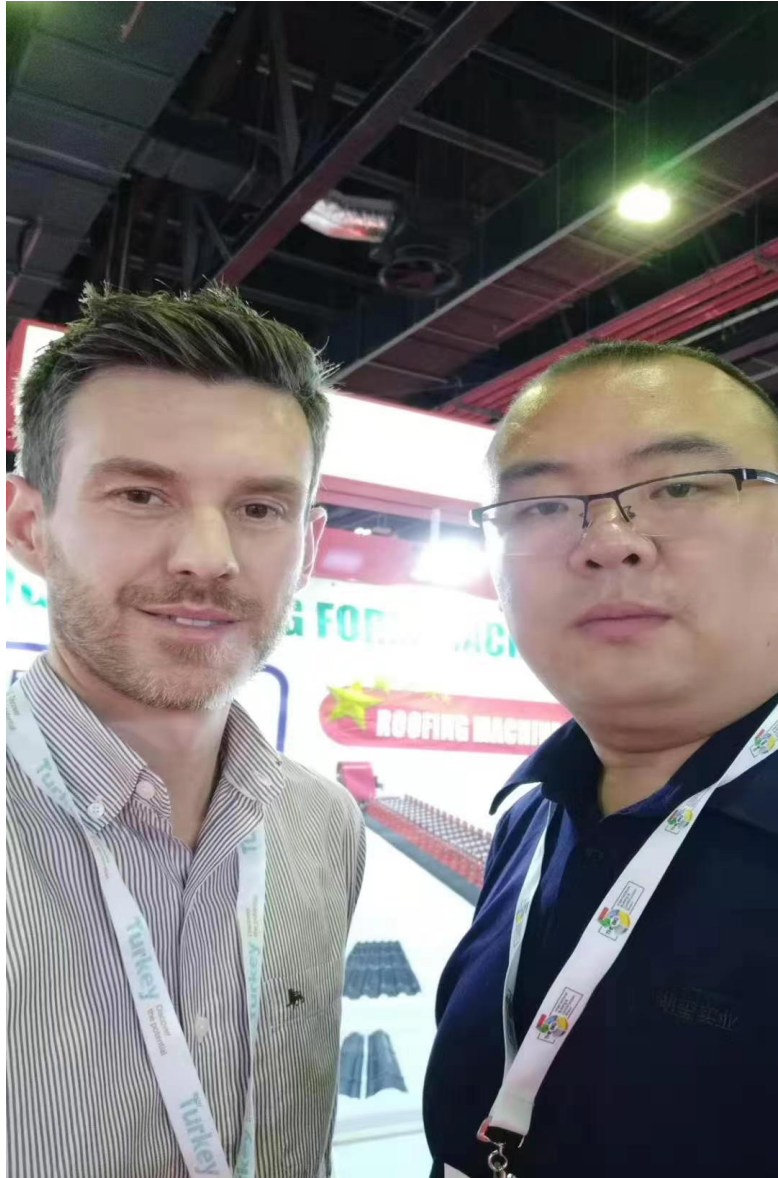



STEEL STAR
www.greatforming.com

Product Catalog

1. Roof Sheet Roll Forming Machine

1-1 Single Model Trapezoidal Roof Sheet Roll Forming Machine

Application Scenarios





1-1 Single Model Trapezoidal Roof Sheet Roll Forming Machine

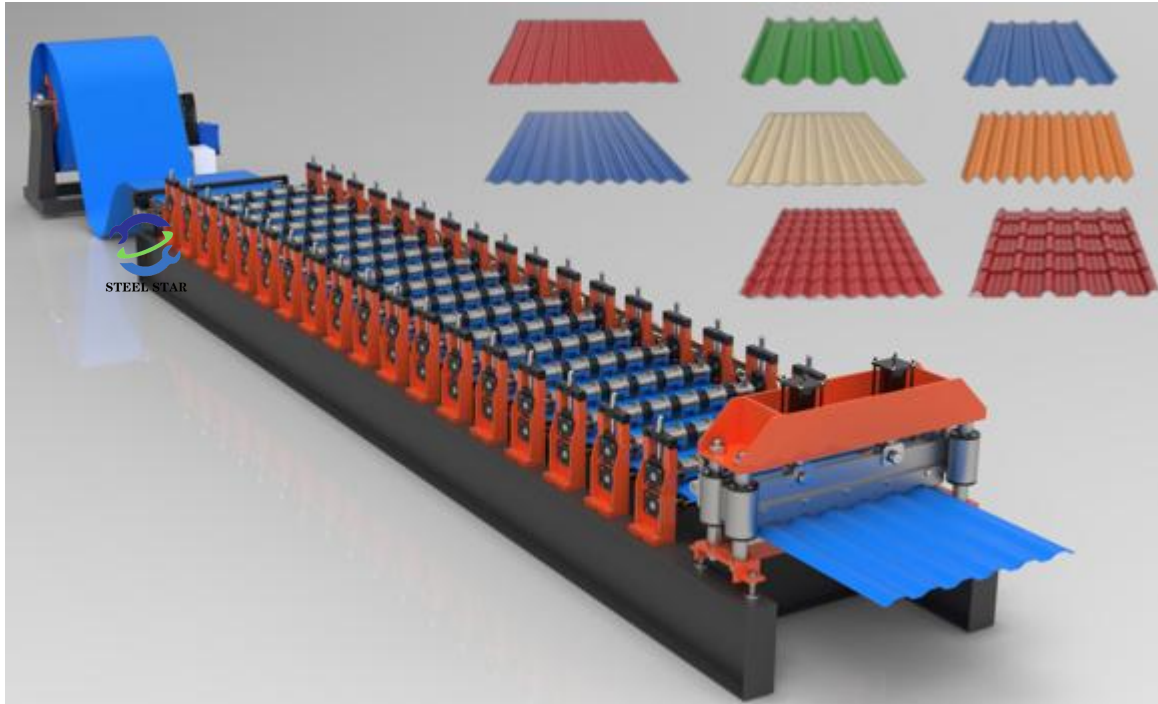

Trapezoidal roofing sheet

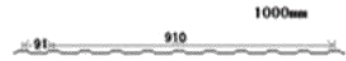

YX 6-91-910



YX 15-225-900

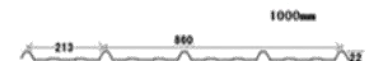

YX 22-213-860

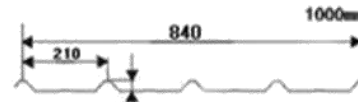

YX 25-210-840

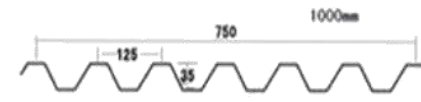
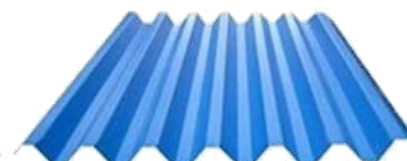

YX 35-130125-750

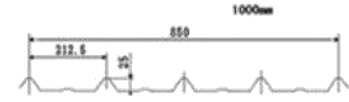

YX 25-212.5-850

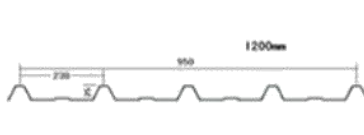
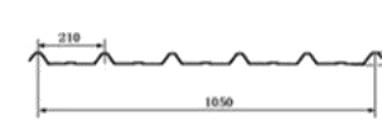
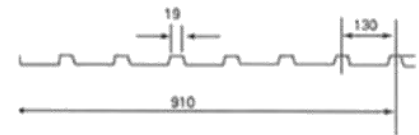



STEEL STAR
www.greatforming.com

Product Catalog

1. Roof Sheet Roll Forming Machine

1-2 Single Model Corrugated Roof Sheet Roll Forming Machine

Application Scenarios

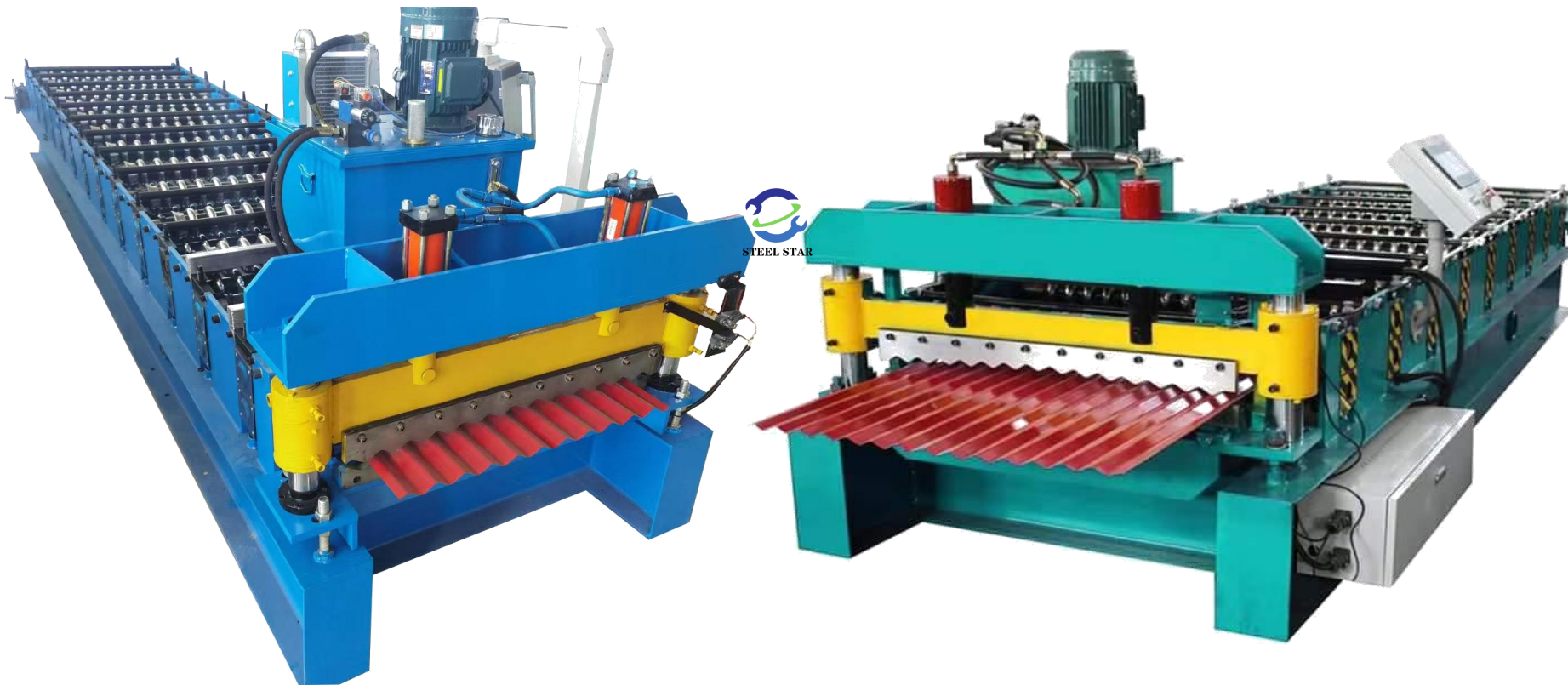



1-2 Single Model Corrugated Roof Sheet Roll Forming Machine

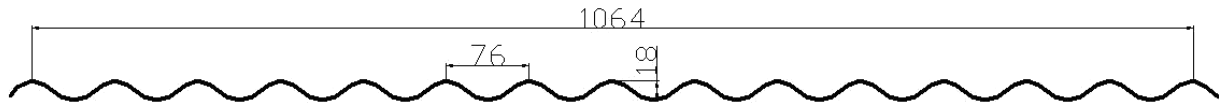

进料宽度: 1250mm

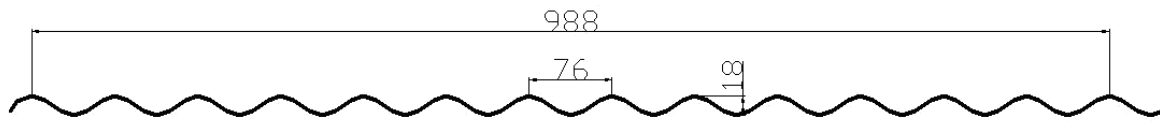

进料宽度: 1200mm

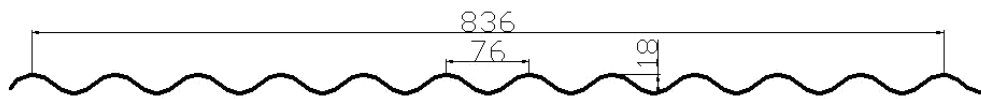

进料宽度: 1000mm

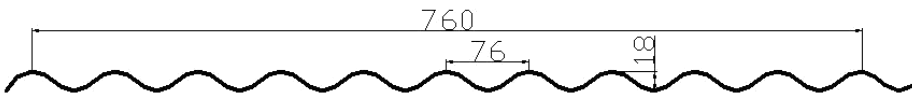

进料宽度: 940mm

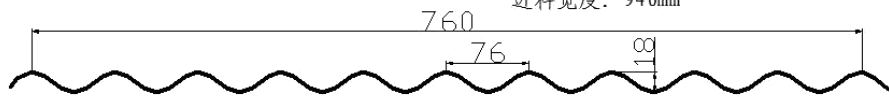

进料宽度: 914mm

Wave roofing sheet

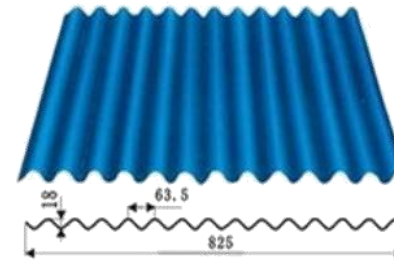

YX 18-63.5-825

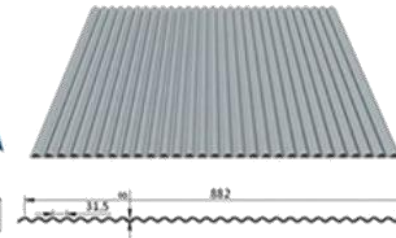

YX 8-31.5-882

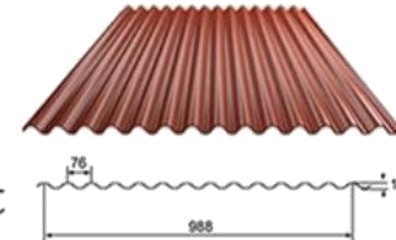

YX 18-76-988

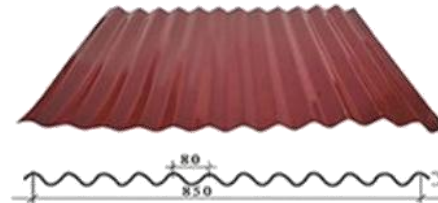

YX 15-80-850

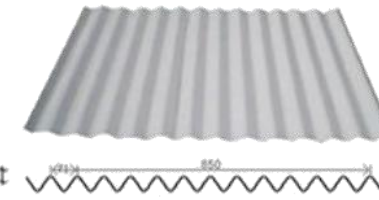

YX 15-71-850

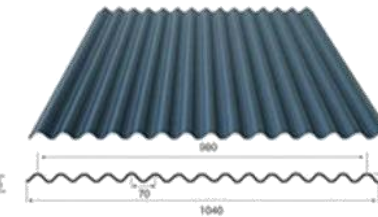

YX 22-70-980

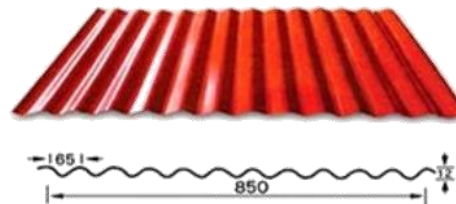

YX 12-65-850

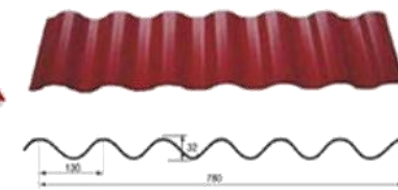

YS 32-130-780

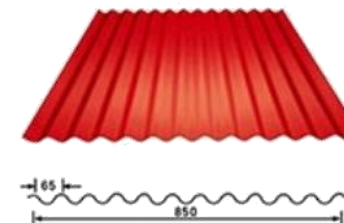

YS 13-65-850



STEEL STAR
www.greatforming.com

Product Catalog

1. Roof Sheet Roll Forming Machine

1-3 Single Model Glazed Tile Roof Sheet Roll Forming Machine



Application Scenarios





STEEL STAR
www.greatforming.com

Product Catalog

1. Roof Sheet Roll Forming Machine

1-3 Single Model Glazed Tile Roof Sheet Roll Forming Machine



Glazed roofing sheet

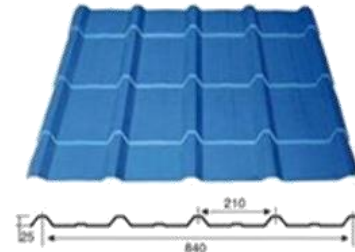

YX 25-210-840

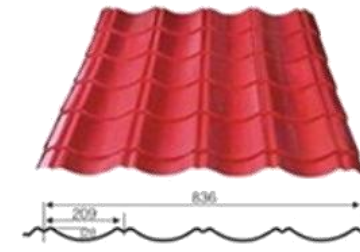

YX 28-29-836

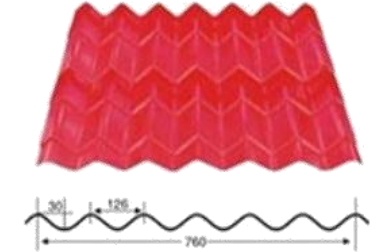

YX 30-126-760

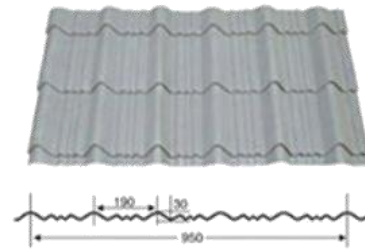

YX 30-190-950

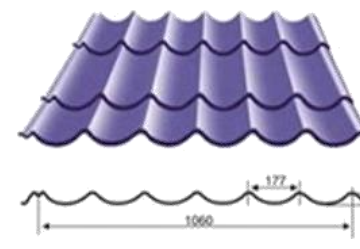

YX 30-177-1060

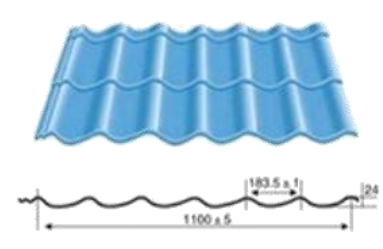

YX 24-183.5-1100

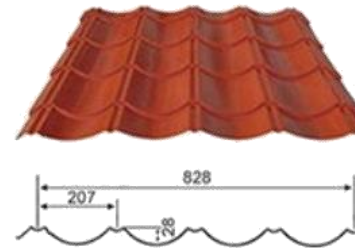

YX 28-207-828

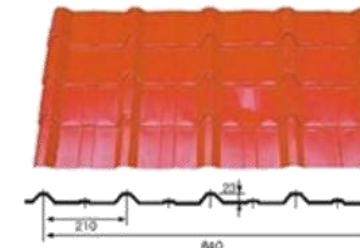

YX 28-207-828

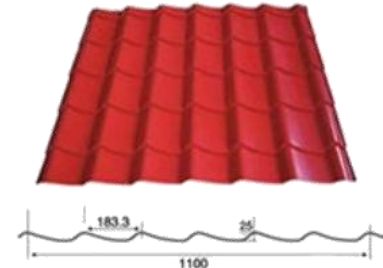

YX 25-183.3-1100



Product Catalog

1. Roof Sheet Roll Forming Machine

STEEL STAR
www.greatforming.com

1-4 Double Layer/Double Models Roof Sheet Roll Forming Machine

Application Scenarios

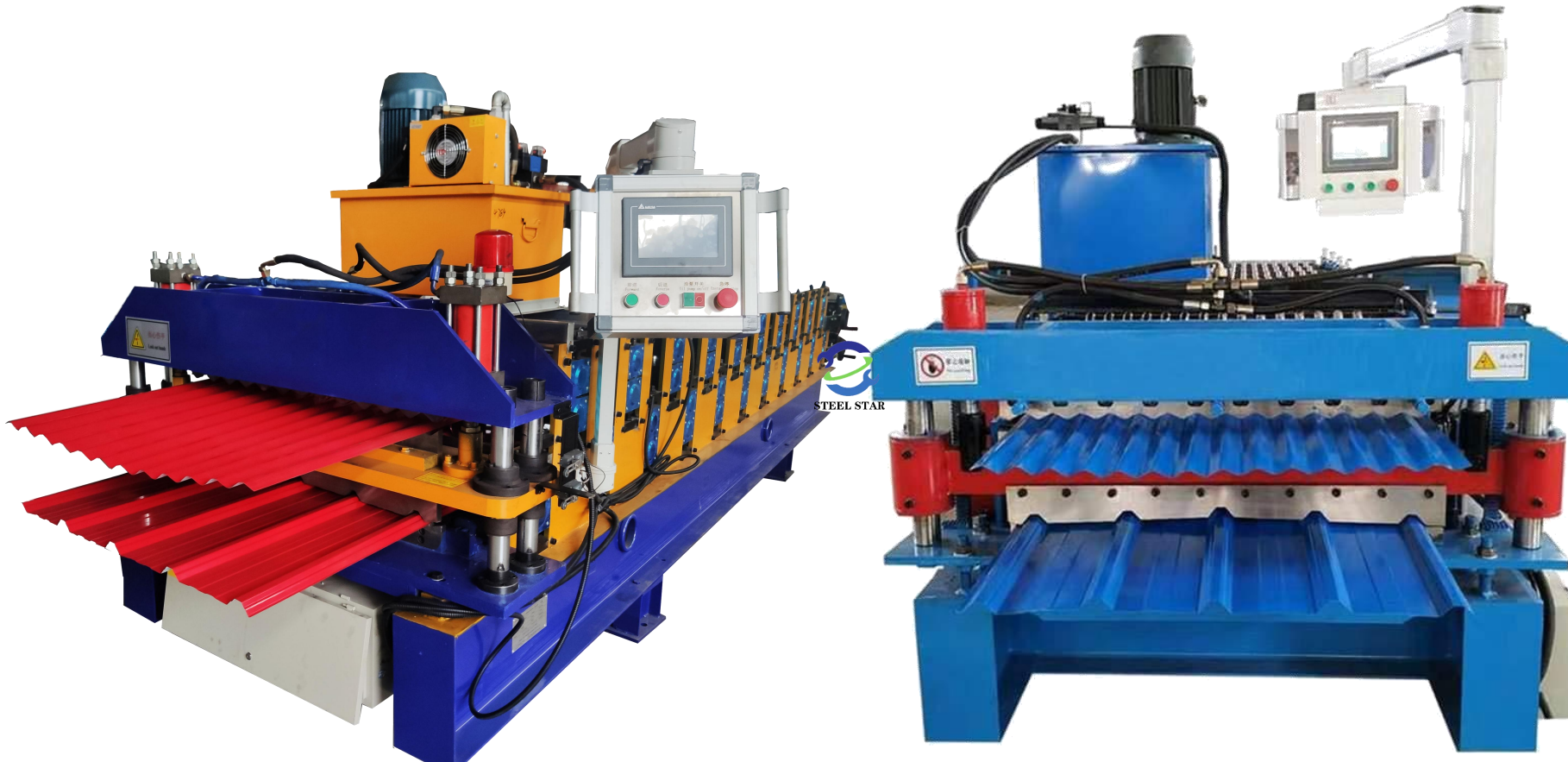



STEEL STAR
www.greatforming.com

Product Catalog

1. Roof Sheet Roll Forming Machine

1-5 Double Layer/Double Models Glazed Tile Roof Sheet Roll Forming Machine

Application Scenarios

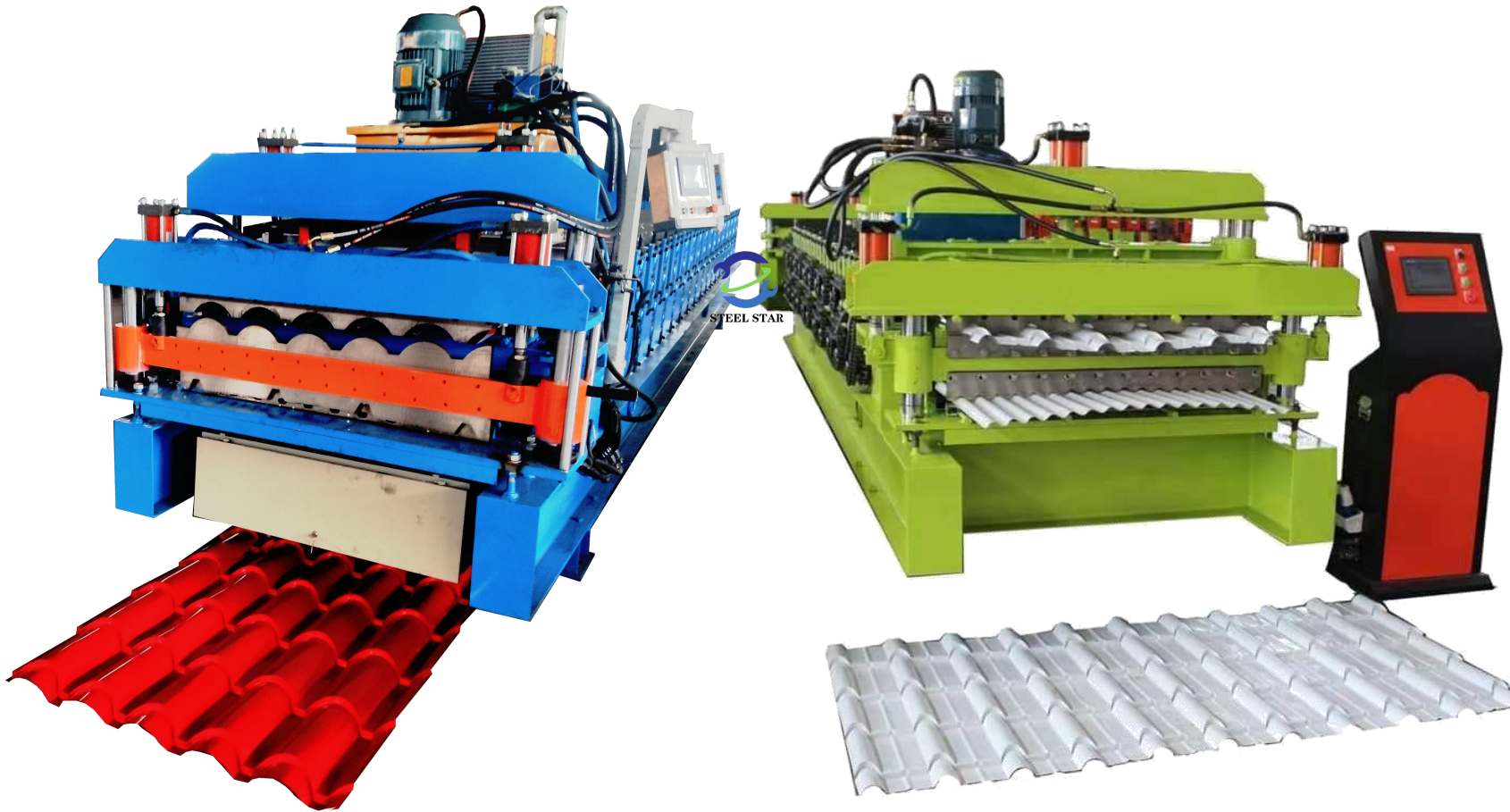



1-6 Three Layer/Three Models Roof Sheet Roll Forming Machine

Application Scenarios





STEEL STAR
www.greatforming.com

Product Catalog

1. Roof Sheet Roll Forming Machine

1-7 Fully Automatic Roof Sheet Arching Machine

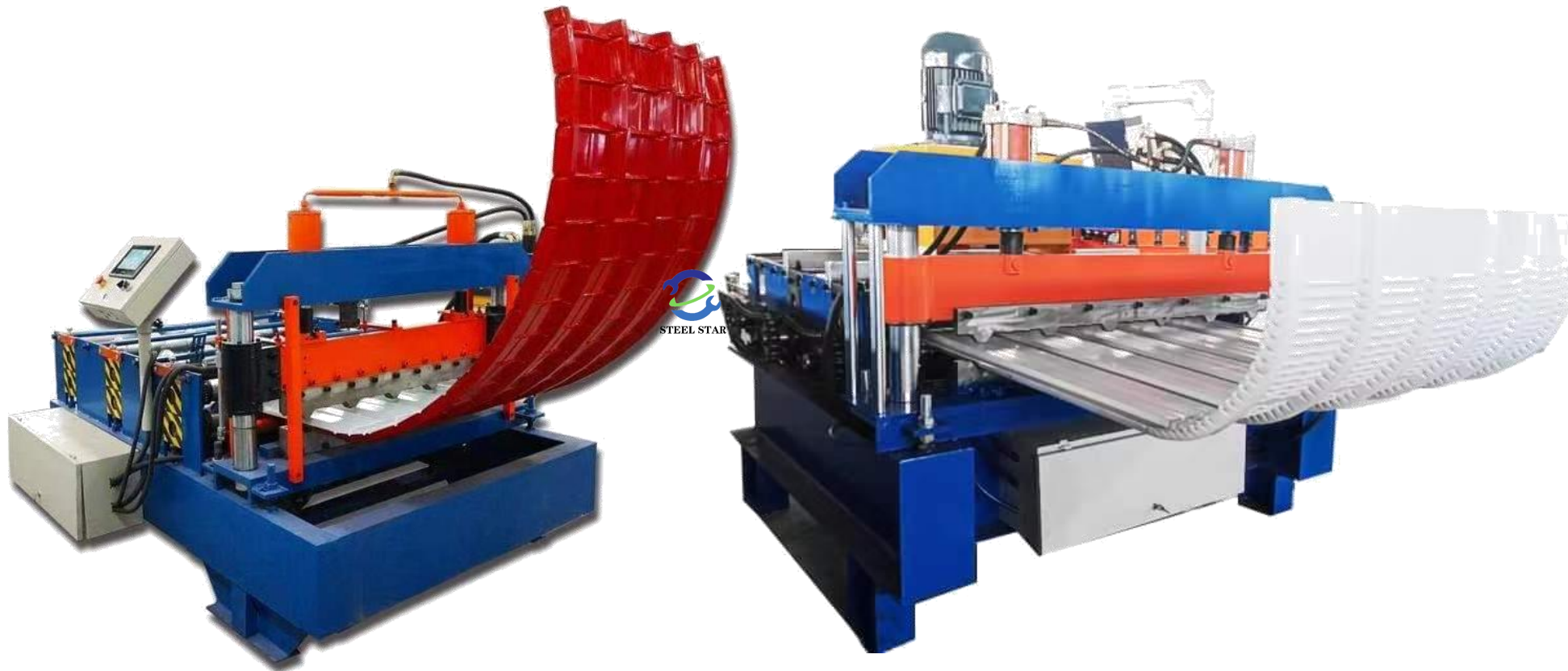

Application Scenarios



2-1 Light Keel Stud And Track C/U/V/Omega Roll Forming Machine

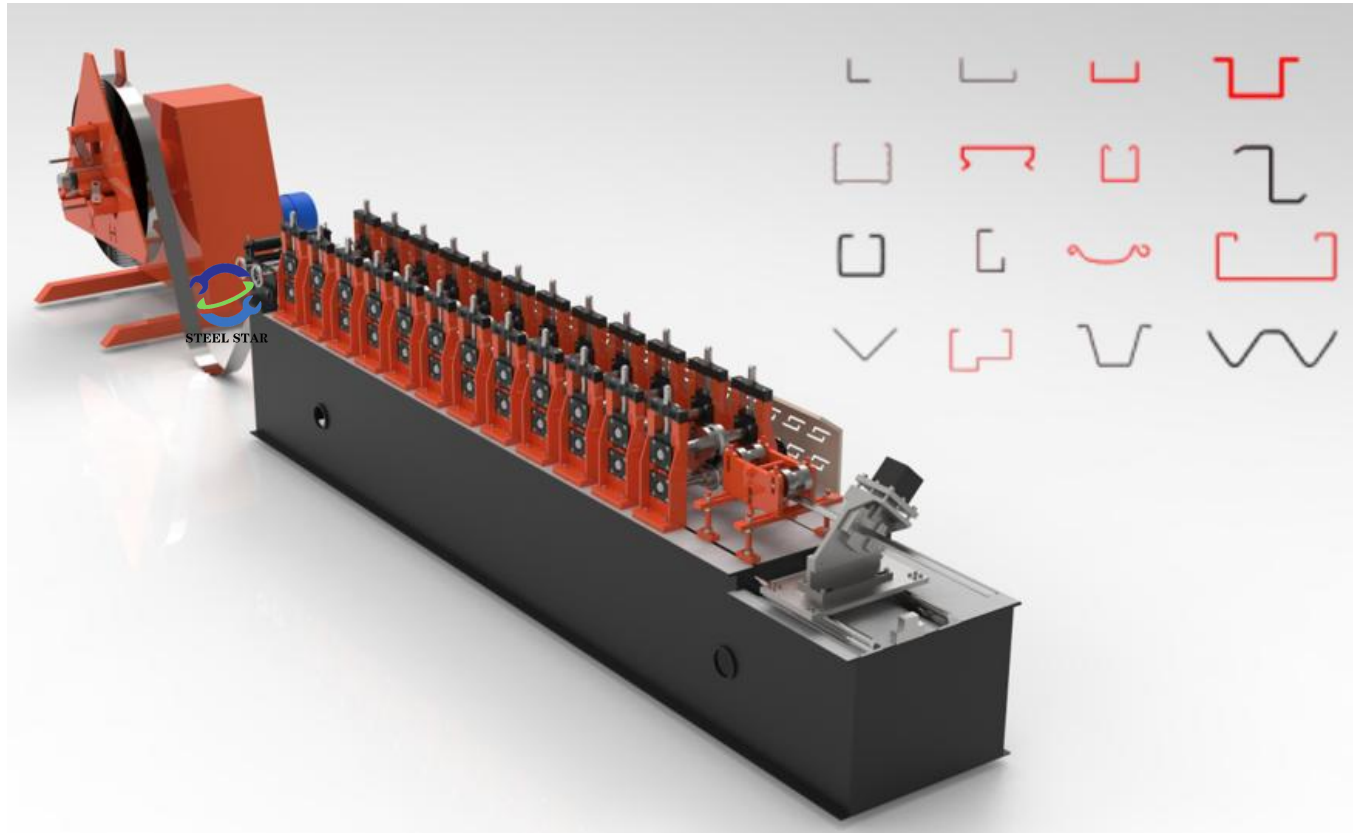

High--speed

20m--150m/min

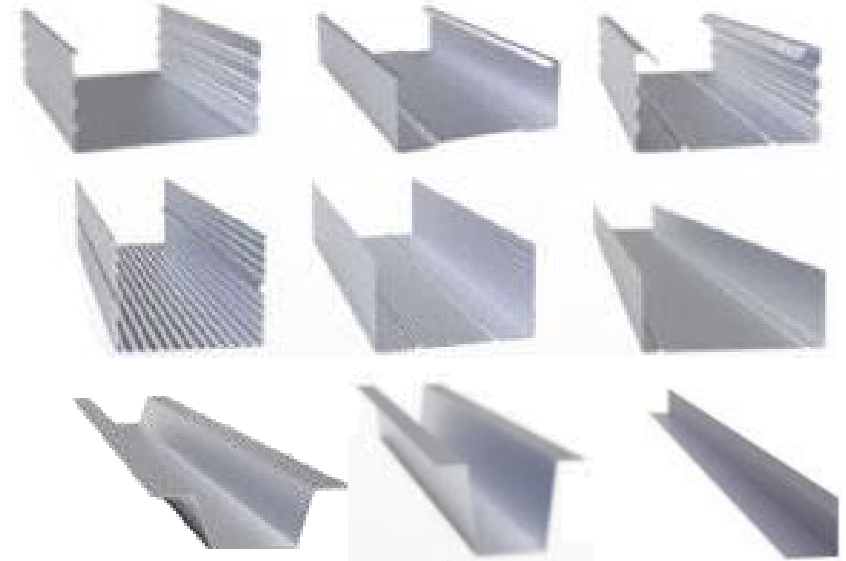

2-1 Light Keel Stud And Track C/U/V/Omega Roll Forming Machine

Application Scenarios

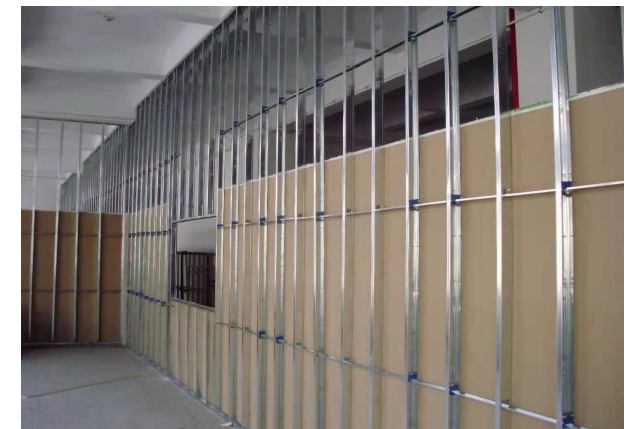
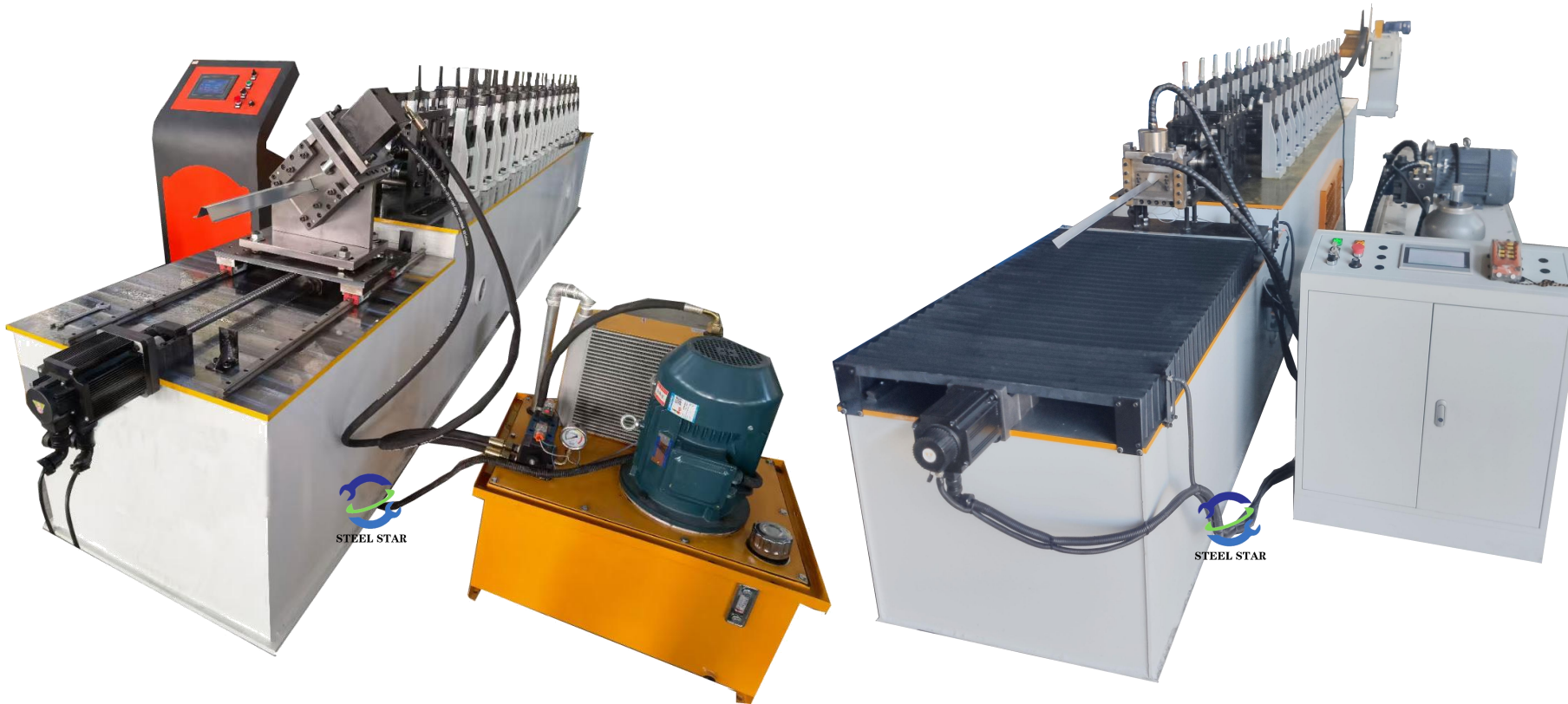



STEEL STAR
www.greatforming.com

High Speed Light Keel Roll Forming Machine

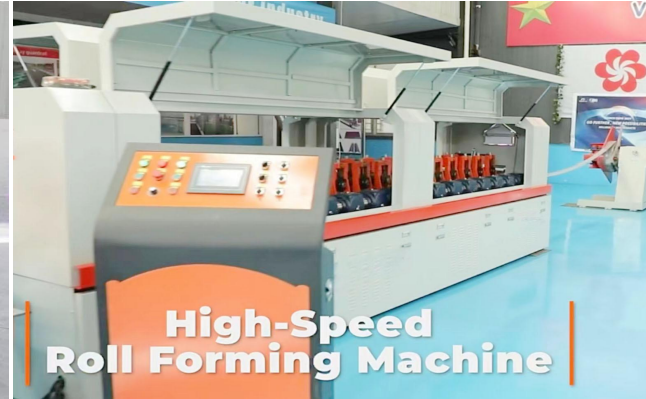

High-Speed Roll Forming Machine

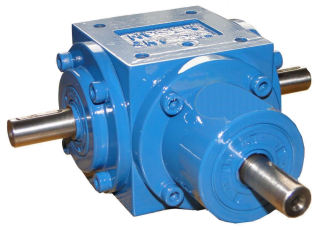

Gear Box Structure

High Speed 50m-150m/min

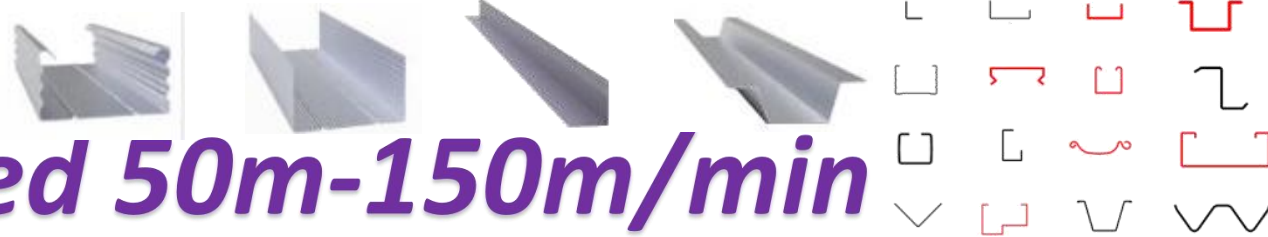

C--Model

U--Model

V--Model

Omega--Model

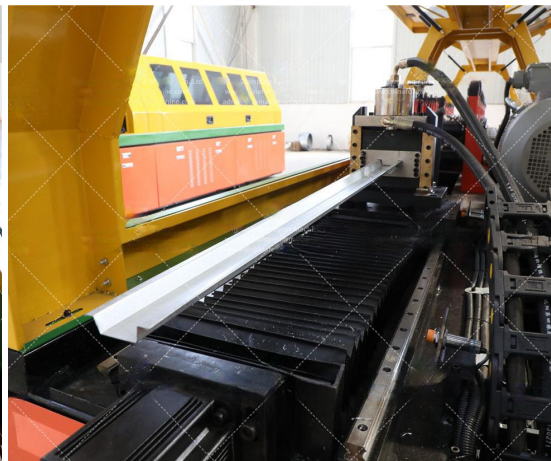



3-1 Shutter Door Roll Forming Machine

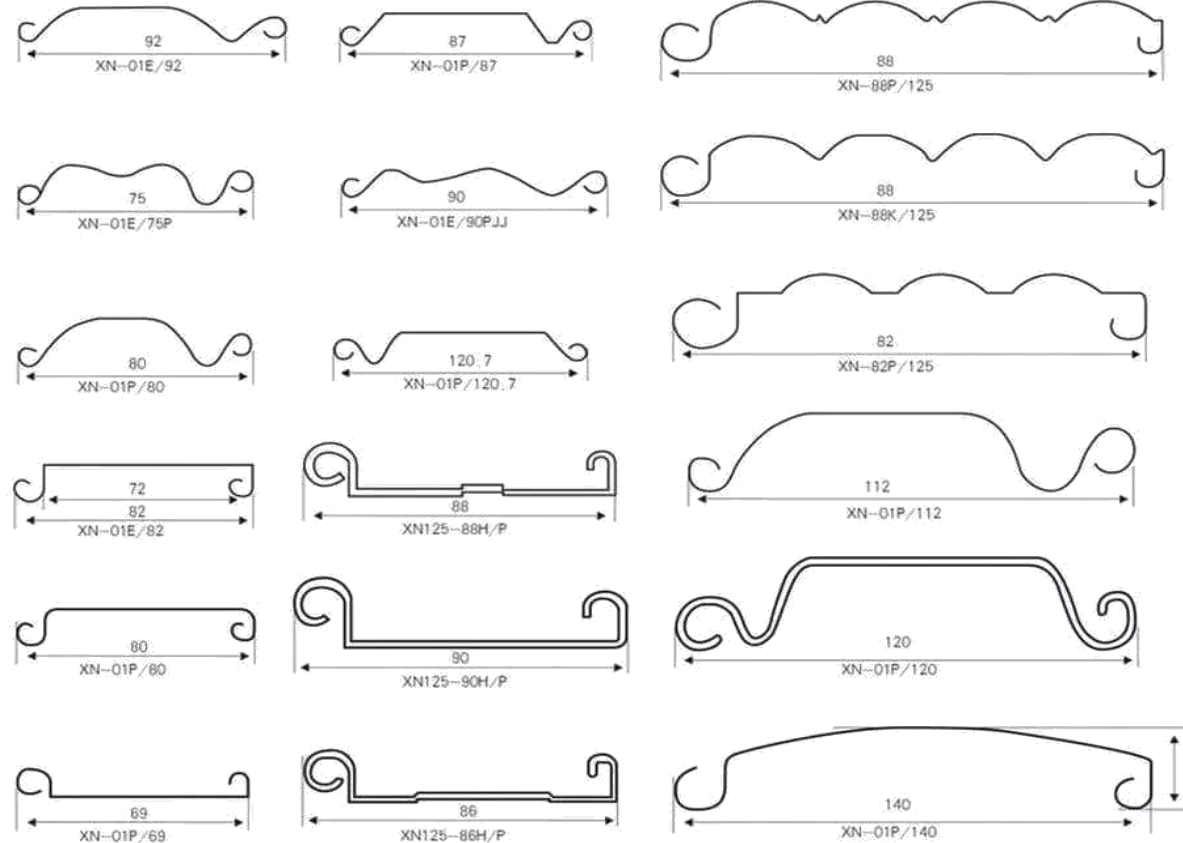
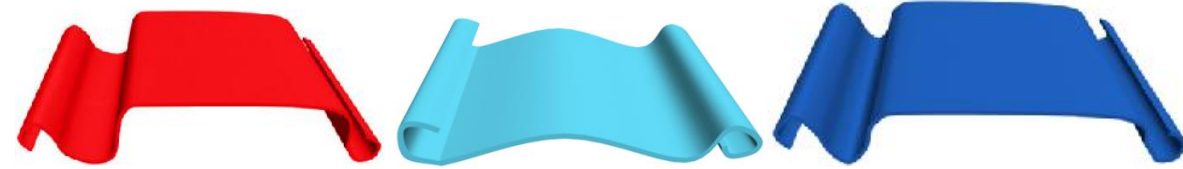
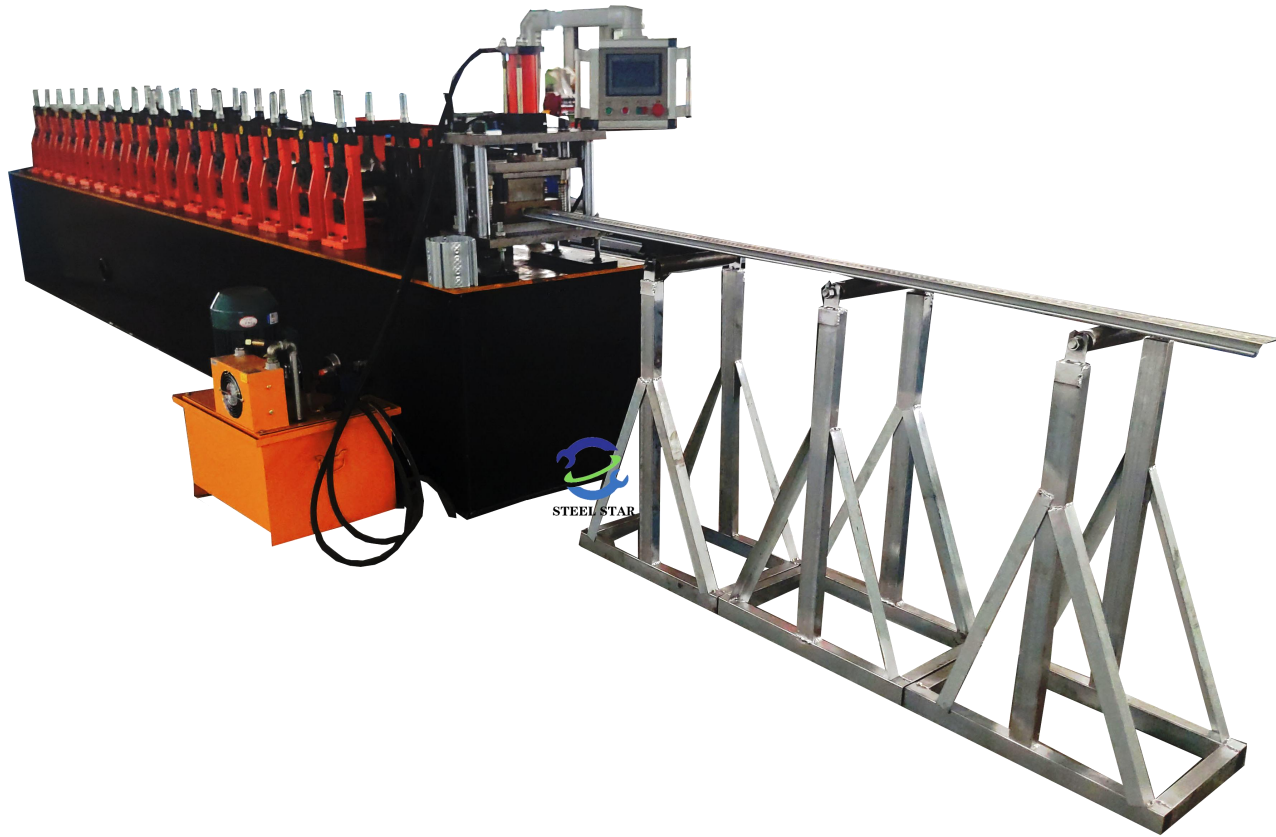



3-1 Shutter Door Roll Forming Machine

Application Scenarios

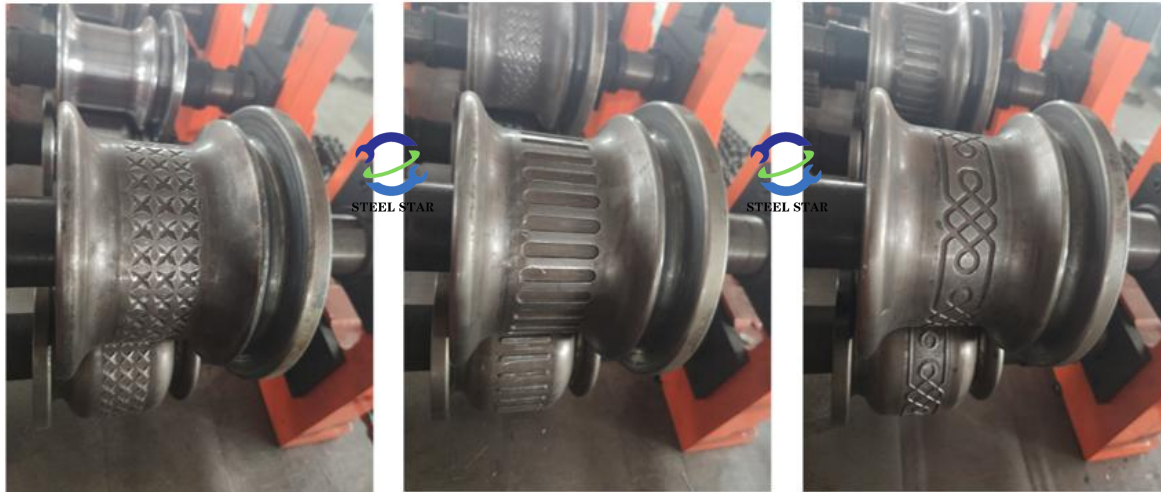



STEEL STAR
www.greatforming.com

Product Catalog

4. C/Z Purlin Roll Forming Machine

4-1 C/Z Purlin Roll Forming Machine

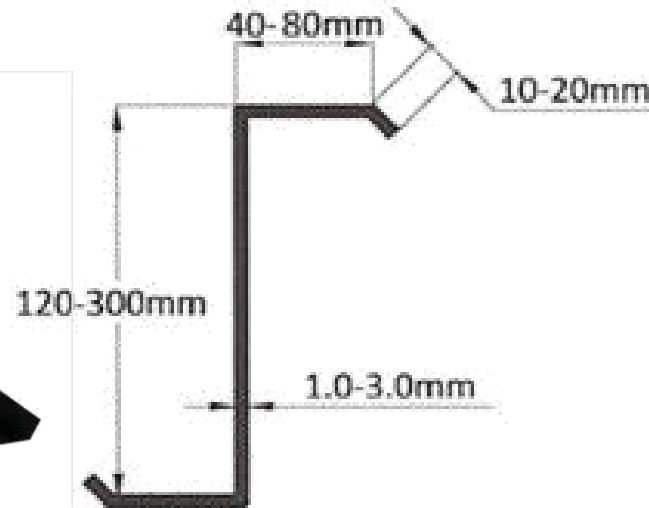
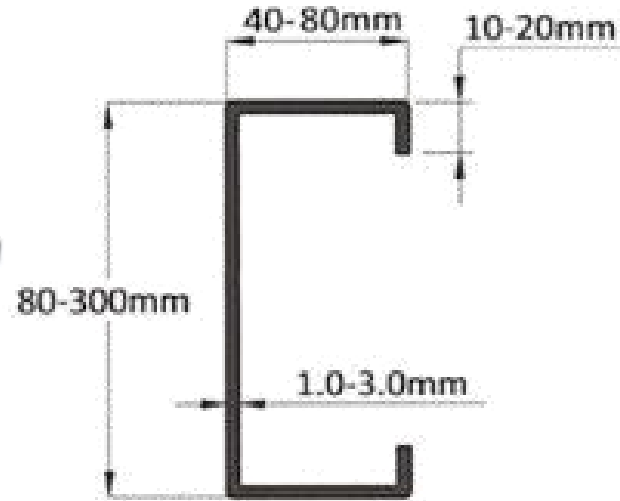
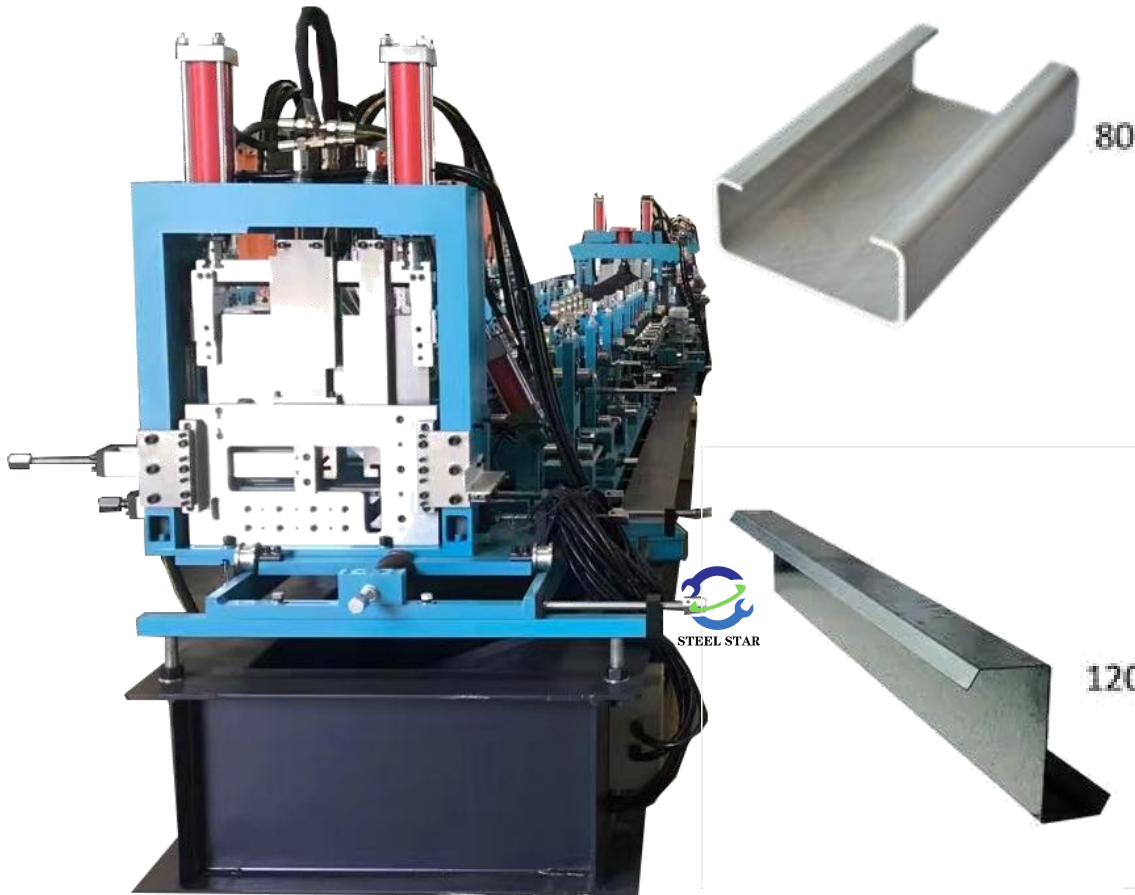

Application Scenarios

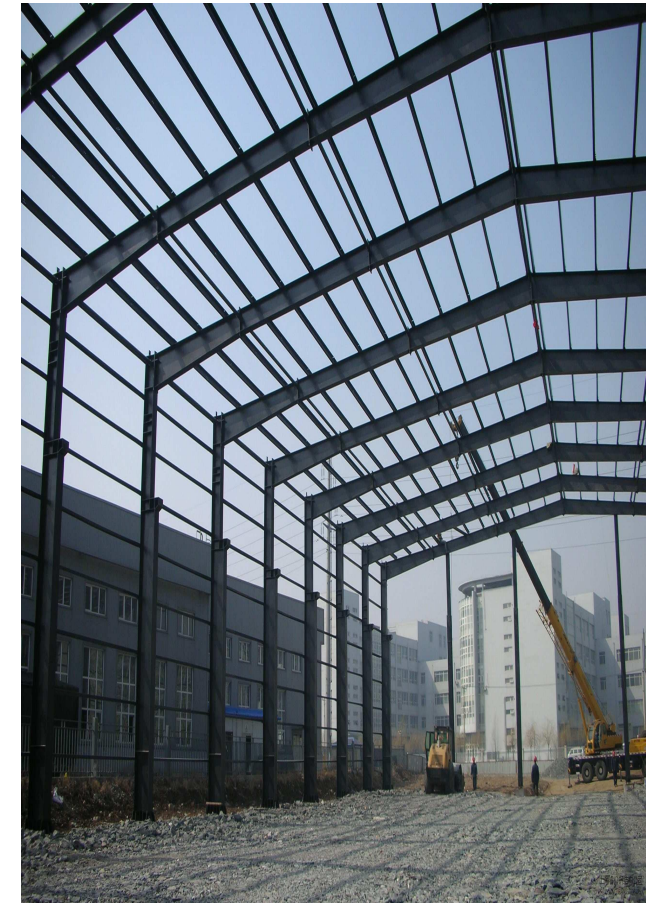



STEEL STAR
www.greatforming.com

Product Catalog

5. Ridge Cap Roll Forming Machine

5-1 Ridge Cap Roll Forming Machine



Application Scenarios



6-1 Barrel Corrugated Roll Forming Machine

Application Scenarios

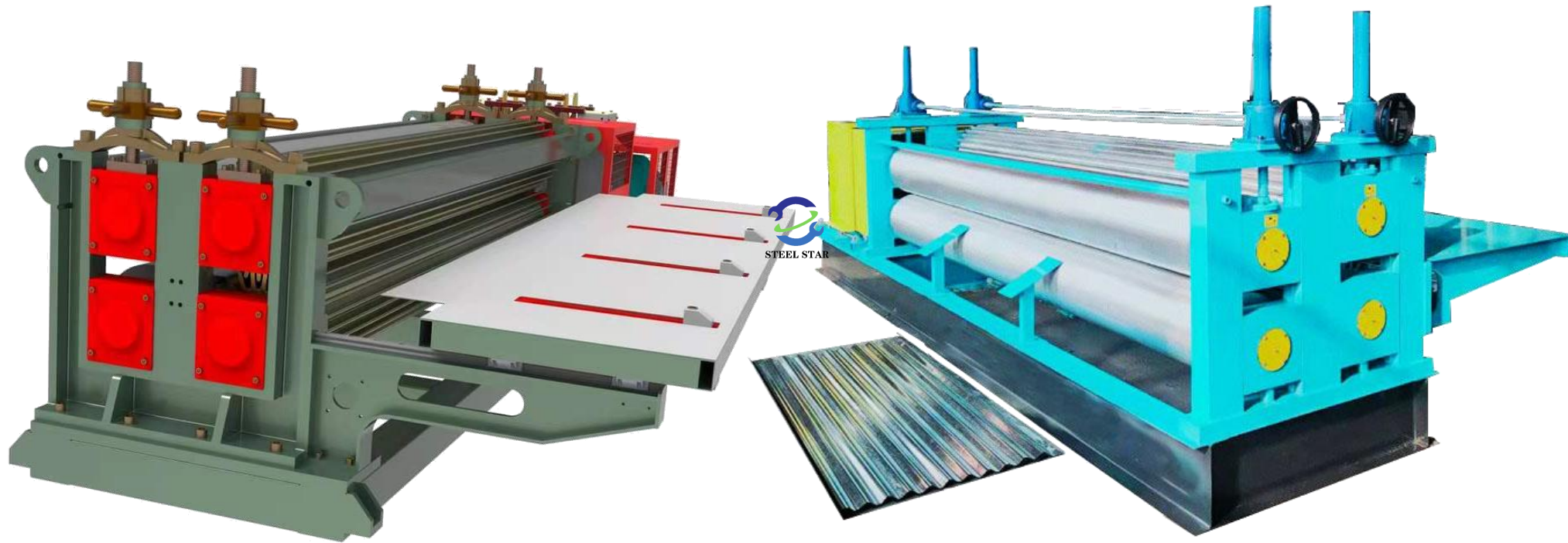



STEEL STAR
www.greatforming.com

Product Catalog

7. Floor Deck Roll Forming Machine

7-1 Floor Deck Roll Forming Machine

Application Scenarios





STEEL STAR
www.greatforming.com

Product Catalog

8. Car Board Roll Forming Machine

8-1 Car Board Roll Forming Machine

Application Scenarios

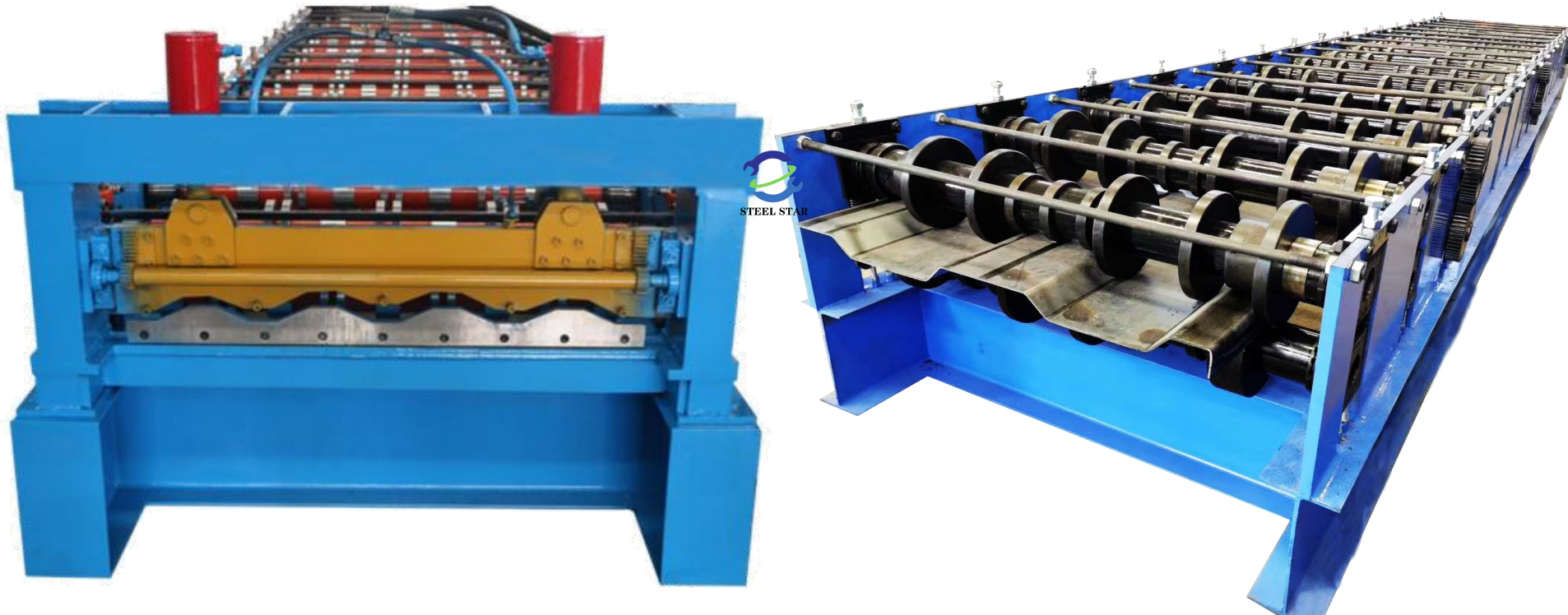



STEEL STAR
www.greatforming.com

Product Catalog

9. Rain Gutter / Downspouts Roll Forming Machine

9-1 Rain Gutter / Downspouts Roll Forming Machine

Application Scenarios

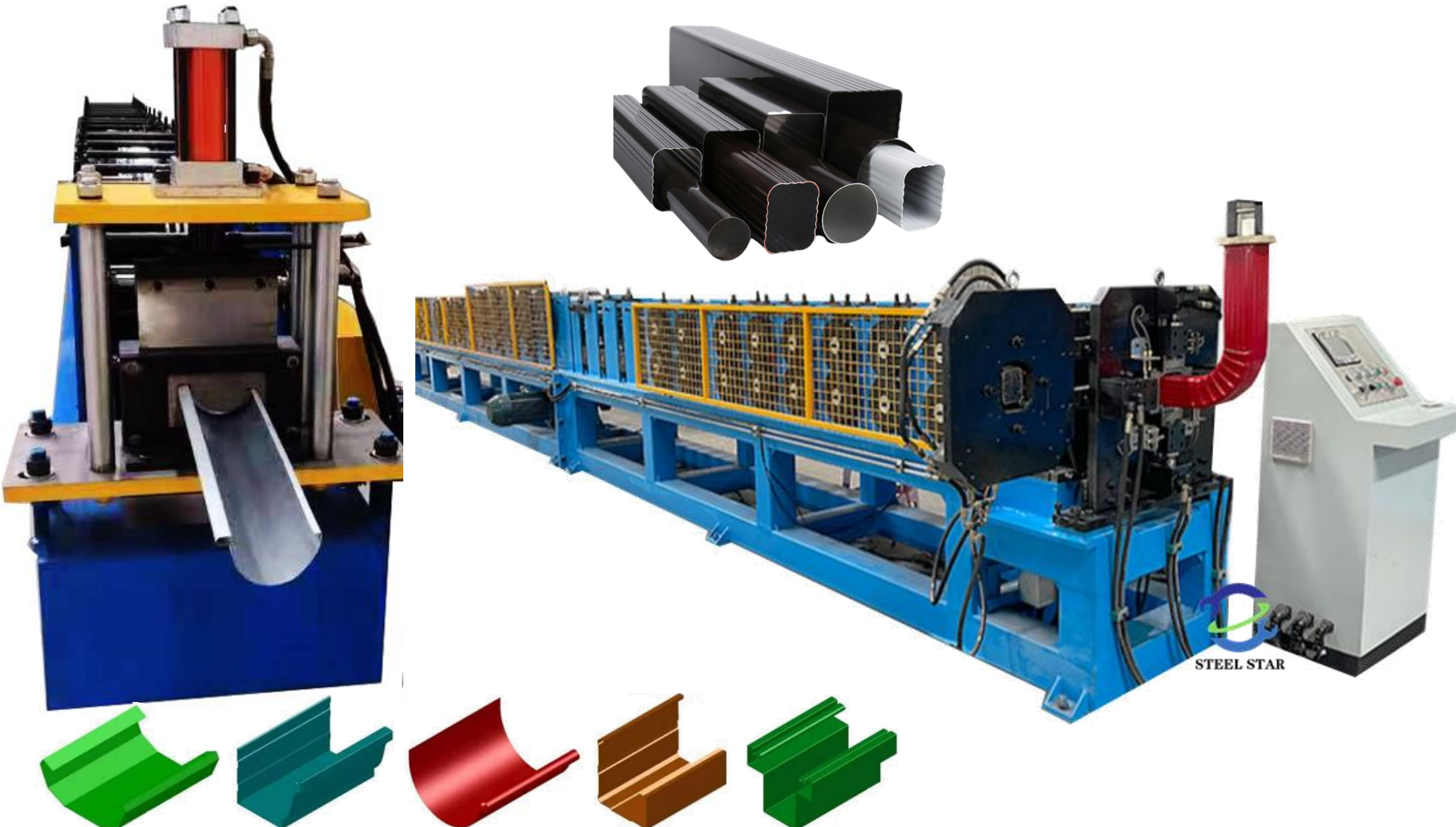



STEEL STAR
www.greatforming.com

Product Catalog

10. Light Keel Villa Frame Roll Forming Machine

10-1 Light Keel Villa Frame Roll Forming Machine

Application Scenarios

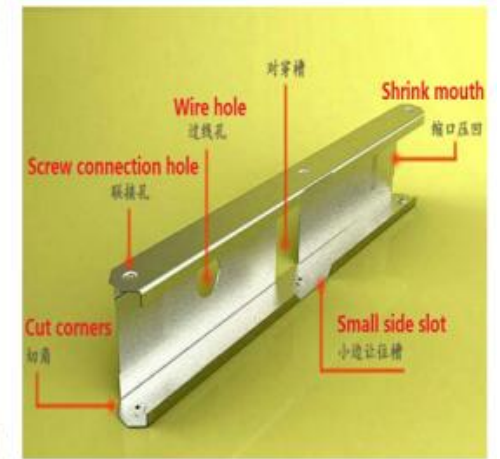
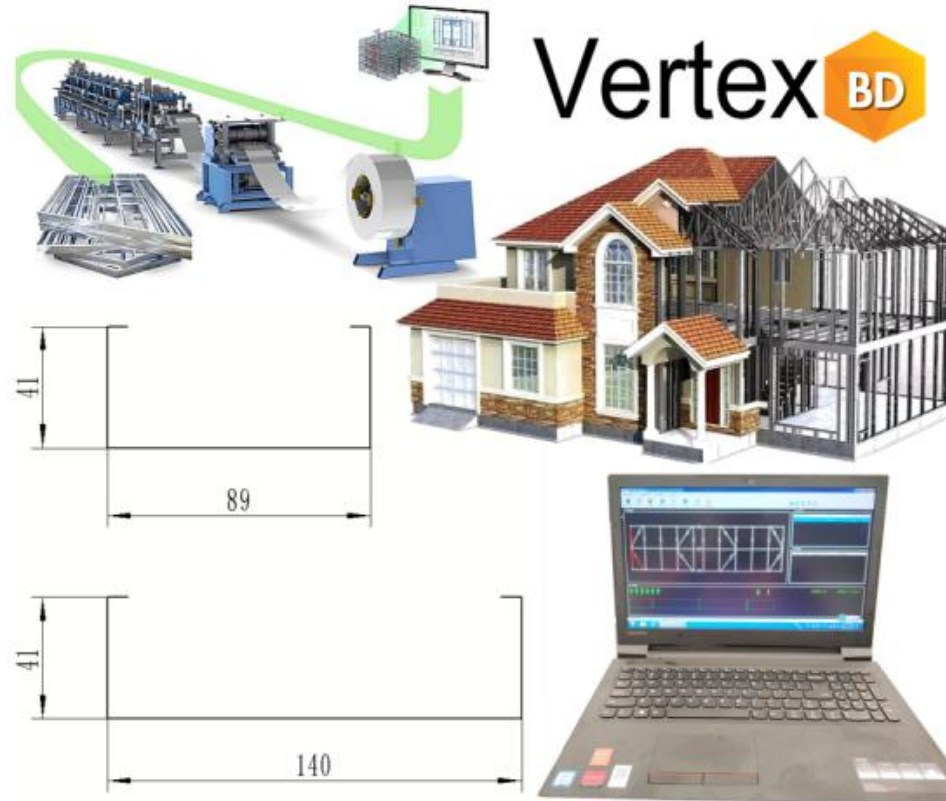



STEEL STAR
www.greatforming.com

Product Catalog

11. Guardrail Plate Roll Forming Machine

11-1 Guardrail Plate Roll Forming Machine

Application Scenarios

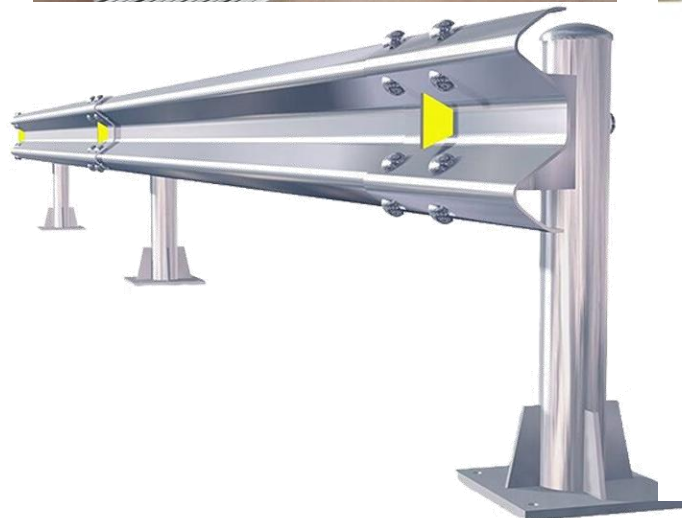
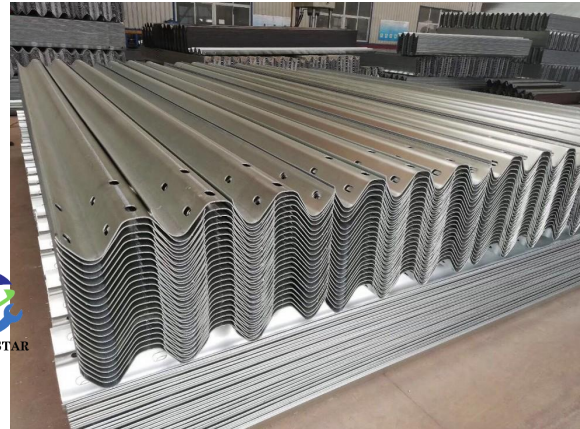

Product Catalog 12. Foam/Rock Wool Roof Sheet Composite Production Line

12-1 Foam/Rock Wool Roof Sheet Composite Production Line

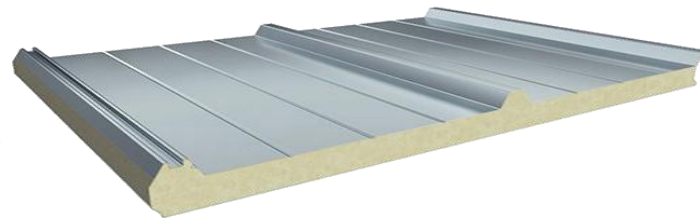
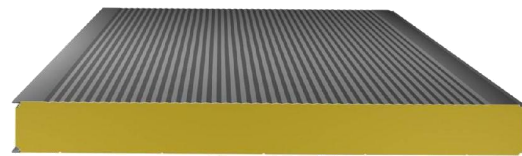
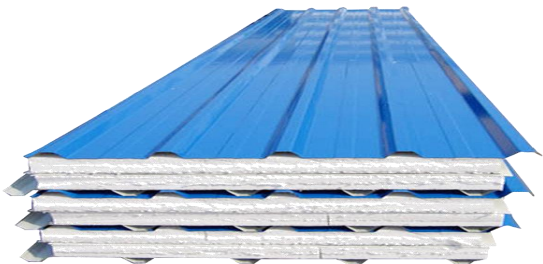

Application Scenarios



13-1 Decoiler / Auto Stacker Roof Panel Sheet Machine Roll Forming Machine

Application Scenarios

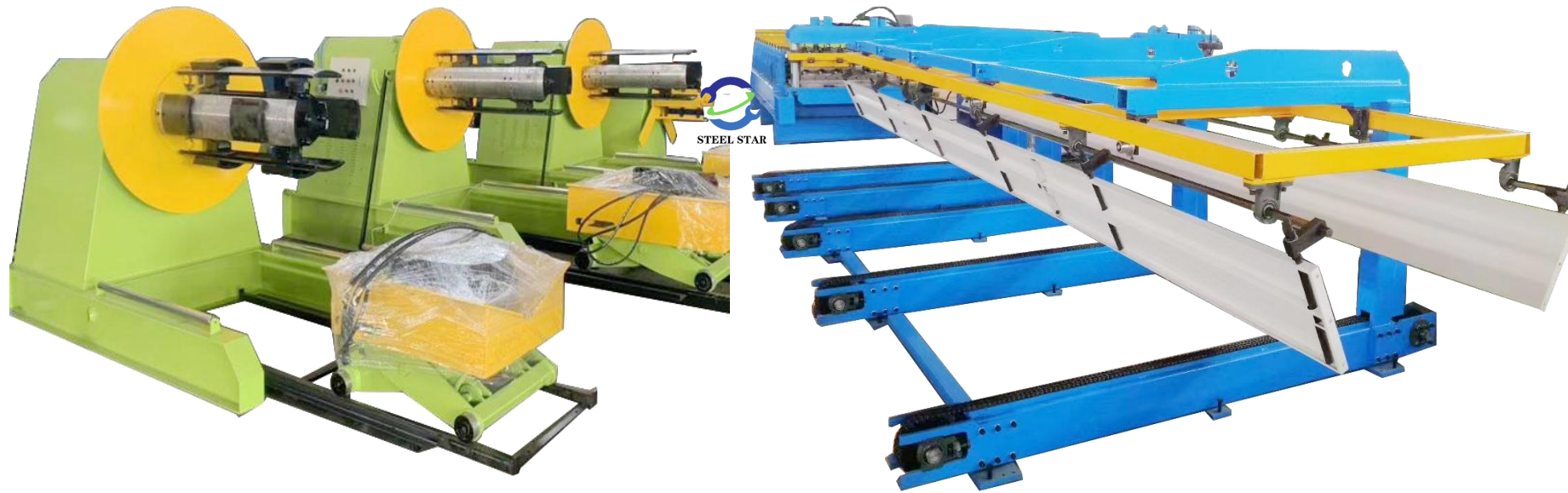



STEEL STAR
www.greatforming.com

Product Catalog 14. Bending Machine / Guillotine Shearing Machine

14-1 Bending Machine/ Guillotine Shearing Machine

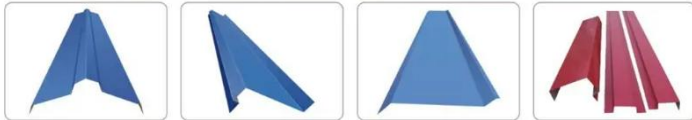
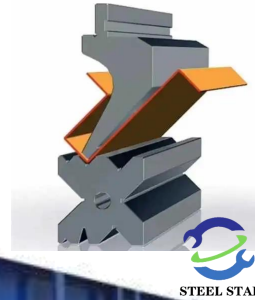
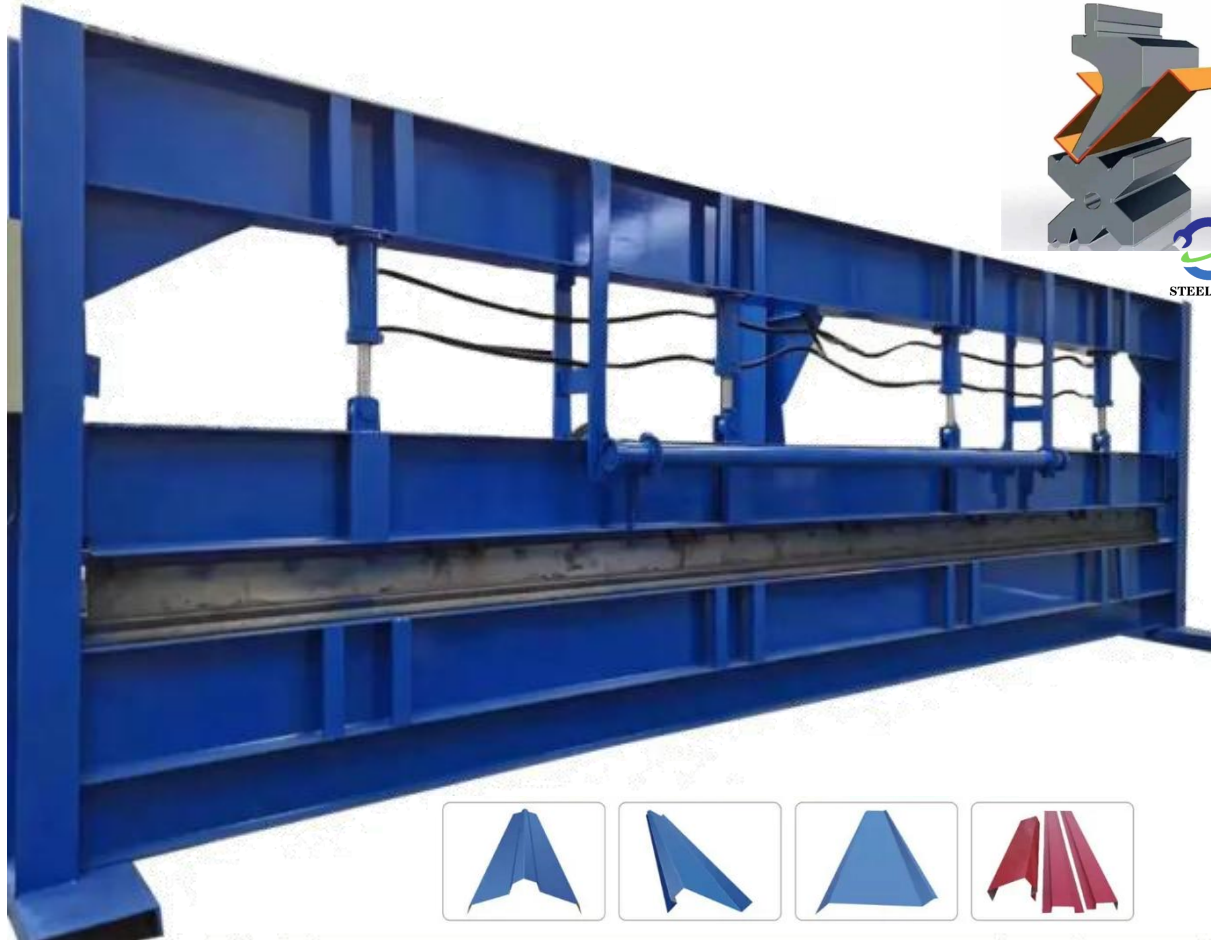



STEEL STAR
www.greatforming.com

Product Catalog 15. Steel Coil Slitting Line Machine

15-1 Steel Coil Slitting Line Machine



Application Scenarios

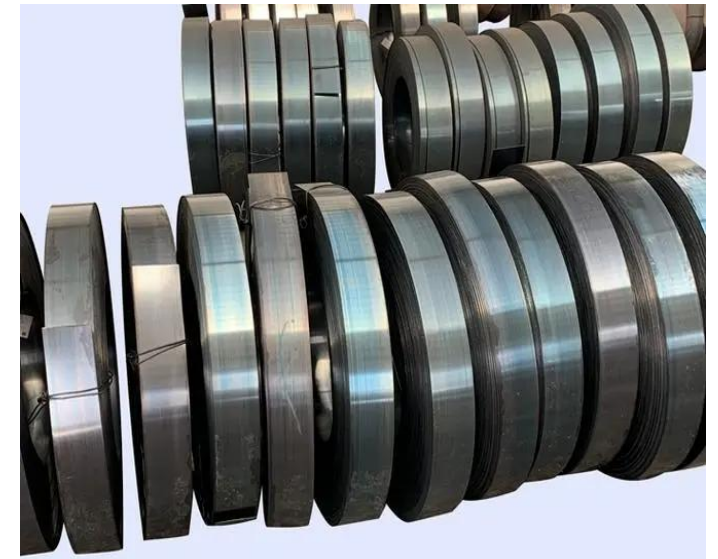
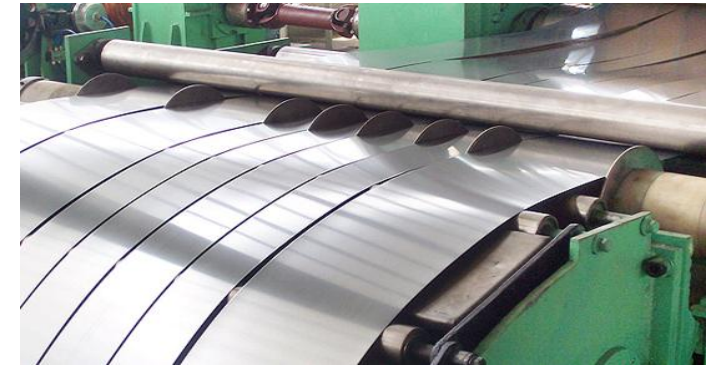



STEEL STAR
www.greatforming.com

Product Catalog 16. Solar Bracket Machine

16-1 Solar Bracket Machine



Application Scenarios





STEEL STAR
www.greatforming.com

Product Catalog 17. Steel Pipe Making Machine

17-1 Steel Pipe Making Machine



Application Scenarios

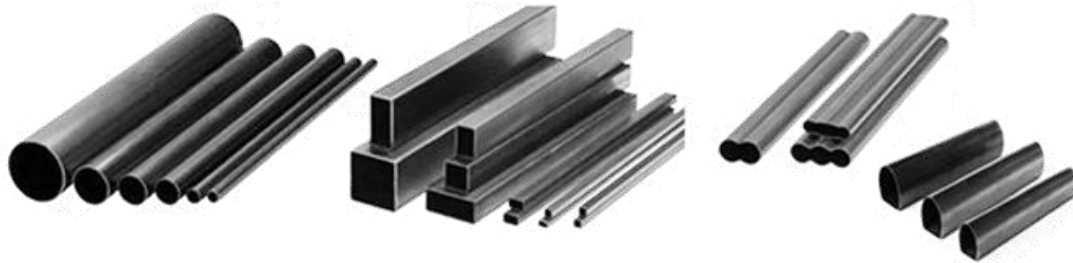



STEEL STAR
www.greatforming.com

Product Catalog 18. Various products can be customized

18-1 Various products can be customized

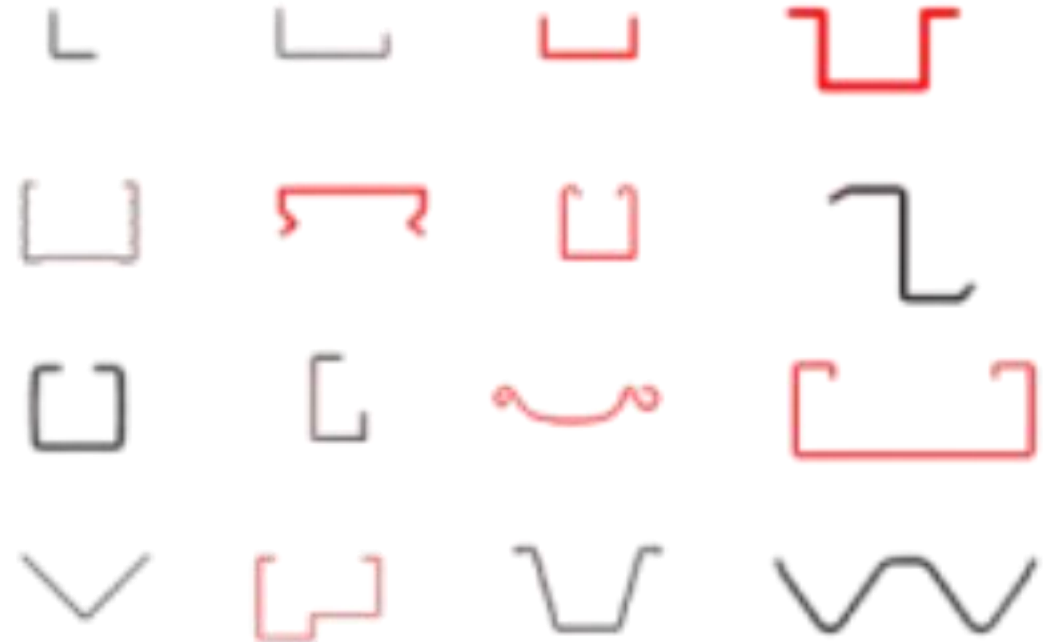



STEEL STAR
www.greatforming.com

Shipping Abroad



STEEL STAR



STEEL STAR
www.greatforming.com

Service



Our customer service will help you solve any problems related to the system: our service is available 24 hours a day during working days. We will answer your questions quickly and reliably.

If necessary, we will send professional debugging and installation equipment personnel who can go to your city and help you install the equipment on site.





STEEL STAR
www.greatforming.com

Contact Us



+86 16630722266

WhatsApp Wechat

Email : sam@greatforming.com

Official website : www.greatforming.com



China



Beijing		1 Hour	
		4 Hour	

Tianjin		0.5 Hour	
		2.5 Hour	

Jinan		1 Hour	
		3 Hour	